



A2 Series LED Photoelectric Controls

The A2 Series is a complete photoelectric control in a case small enough to conceal in your shirt pocket. Whether you need AC or DC input, ON/OFF or time delay, there is a version to do the job.

Standard features include a red LED status indicator visible over 180°, sensitivity adjustment and a phase switch for LIGHT or DARK operation. The tough glass-filled Noryl case has a permanently sealed cover and gasketed

replaceable acrylic lens. A rear gasketed access door allows easy adjustment of timing, sensitivity and phase and fastens in place when not in use. This tight construction keeps out dirt and moisture in those problem areas of the plant.

The A2 Series has all solid-state design including pulsed infrared LED Light and solid-state switching to virtually eliminate failures due to component wear.

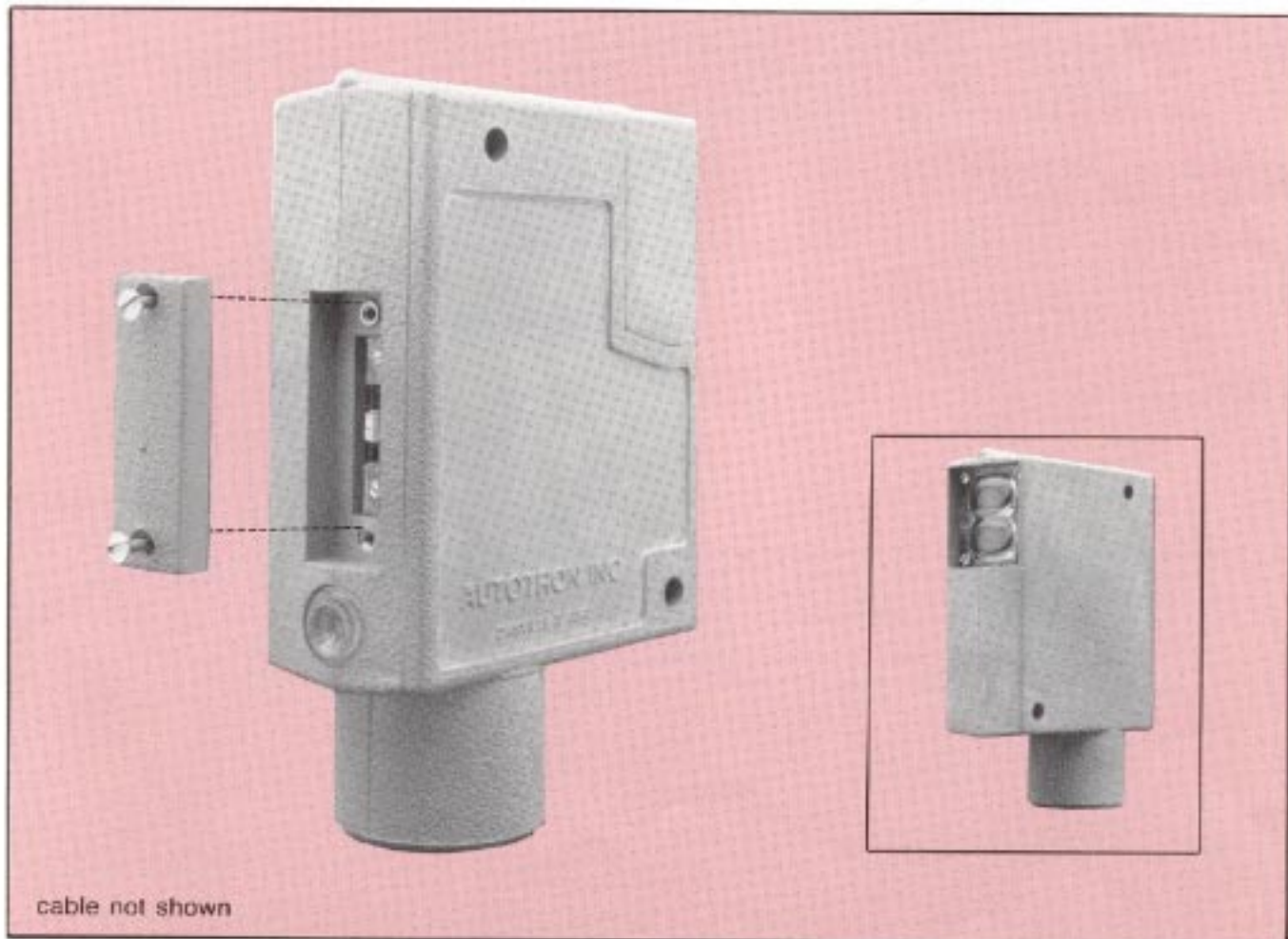

cable not shown

AC or DC • ON/OFF or Time Delay

METHODS OF DETECTION

RETRO-REFLECTION

A retro-reflective control generally provides a surer, simpler and more positive detection in applications where a reflector can be used.

Retro-reflective controls project light through the control lens to a retro-reflective surface, which reflects the light directly back to the control lens. The reflective surface may be up to 15° from perpendicular, and may even be vibrating. Reflective discs are more efficient reflectors than retro-reflective tape.

The gain of the control is set so that the control will not respond to light reflected off of the object breaking the light beam. If the object is shiny or glossy, it may be necessary to angle the light beam so that it does not strike the object at right angles.

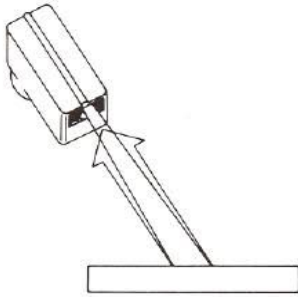

SPECIFY retro-reflective models as **OPTICAL CONFIGURATION 0** in model number key on page 8.

RANGE OFF RETRO SURFACES

Surface	Part No.	Range
3" dia. reflector	P380	0-20 ft.
1 5/8" dia. reflector	P380A	0-15 ft.
1 1/4" dia. reflector	P380AB	0-13 ft.
7/8" dia. reflector	P380B	0-10 ft.
5/8" dia. reflector	P380C	0- 9 ft.
1 1/4" x 3" reflector	P380E	0-15 ft.
1 1/4" x 4" reflector	P380F	0-14 ft.
1" x 1" retro tape	7610	6 in.- 5 ft.
1" x 1" retro tape	3870	6 in.- 5 ft.
1" x 1" retro tape	7800	10 in.- 3 ft.

PROXIMITY (Diffuse Reflection)

Proximity controls are primarily used in applications where retro-reflectors cannot be used. They sense the presence of objects by bouncing light off of the object and detecting the diffuse reflected light. They are best suited to detect the presence or absence of objects, but can be used for color detection if there is enough contrast.

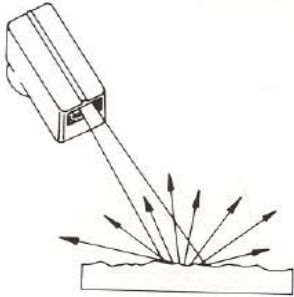

SPECIFY proximity models as **OPTICAL CONFIGURATION 1 OR 2** in model number key on page 8.

RANGE OFF 90% DIFFUSE WHITE SURFACE

Configuration	No.	Range
Long-range prox	1	0-12 in.
Short-range prox	2	0- 4 in.

SHORT RANGE OPTICS

- For applications where object is very close
- Config. 2 is the same as Config. 1 except a different optical design provides peak response at a shorter range and minimal response from more distant objects.
- Optics are behind a smooth surface to prevent accumulation of dirt in cavities.

THROUGH BEAM

Through-beam detection is generally considered better than retro or proximity detection because of greater sensing range and freedom from false detection of shiny objects. However, because difficulty in alignment and the necessity of locating a separate light source, this method of detection is not used as often.

SPECIFY through-beam models as **OPTICAL CONFIGURATION 3** in model number key on page 8.

Range: 0 - 20 feet

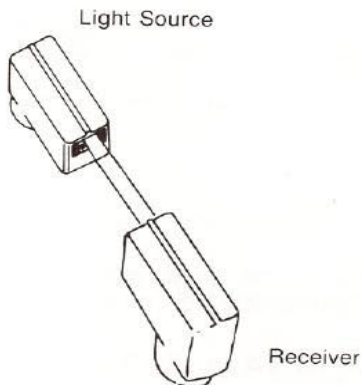

A2 SERIES 2-WIRE AC CONTROL OPERATION

WIRES JUST LIKE A CONVENTIONAL LIMIT SWITCH

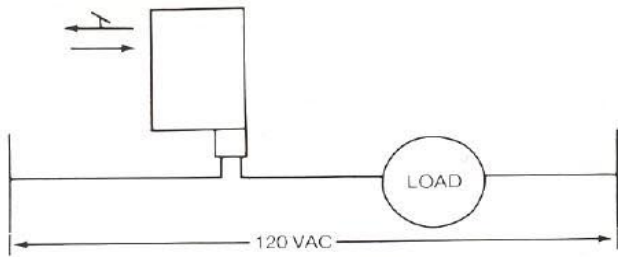

ADVANTAGES OF SOLID-STATE OVER ELECTROMECHANICAL RELAY SWITCHING

- Switch need not be derated for inductive loads
- Indefinitely long life
- Less EMI/RFI generated
- Silent operation
- Shock resistant
- Allows sealed construction

TEST CIRCUIT

Light energized phase: light bulb is on when beam is made.

Dark energized phase: light bulb is off when beam is made.

For both phases: Red LED indicator is on when bulb is on.

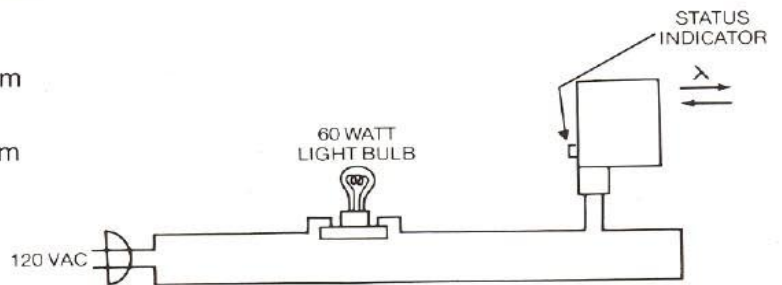

OPERATIONAL CONSIDERATIONS

- All A2 Series Controls have inhibit circuits that prevent the switches from energizing for up to 0.15 seconds after power is applied. Switches should remain powered down for at least 5 seconds to insure the inhibitor will operate on the next power up.
- One side of the case will feel warm to the touch when the switch is carrying current approaching the 1/2 AMP limit.
- Up to hundreds of feet of standard wire can be used.

OFF-State Leakage Current

The 2-Wire AC Controls have minimal OFF-State leakage current. Only in rare cases will it be a factor. However, the user should verify that the leakage current does not cause the load to remain energized. If the leakage causes a problem, the load should be shunted with a resistor to lower the load voltage. In no case should the net load resistance be greater than 20K ohms or less than 230 ohms (approx).

The load may be inductive or resistive between .006 AMP and 1/2 AMP (60VA) continuous at 120 VAC. A simple model of the control is as follows:

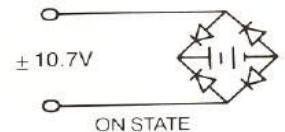
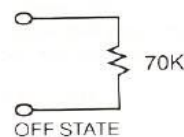

CAUTION

- Do not apply 120 VAC directly to the control without a series load. The control will be destroyed. If possible load shorting is anticipated, consult the factory for fast blow fuses. Standard fuses or circuit breakers open too slowly to protect the semiconductors.
- **The maximum continuous control current should be less than 1/2 AMP or 60 VA at 120 VAC.**
- Disconnect power when wiring as a shock hazard exists in both the ON and the OFF state.
- If a surge suppressor is employed, do not connect it across the load. This will pass the line surge voltage directly into the control. Connect the surge suppressor across the control.

EXCESS GAIN

How well a photoelectric control can perform under less-than-ideal conditions is measured in terms of Excess Gain. Excess Gain is the ratio of the light signal available to the light signal necessary for the control to barely work. The graphs below plot this factor versus range from specific targets. If degrading factors such as dirt, a poorly reflective surface, or misalignment exist, an Excess Gain greater than one (1) is required. How much Excess Gain is required for the application is determined by the customer. An Excess Gain of 3-5 should be allowed for light industrial environments, and 5-8 for moderately dirty environments.

TYPICAL EXCESS GAIN vs. RANGE

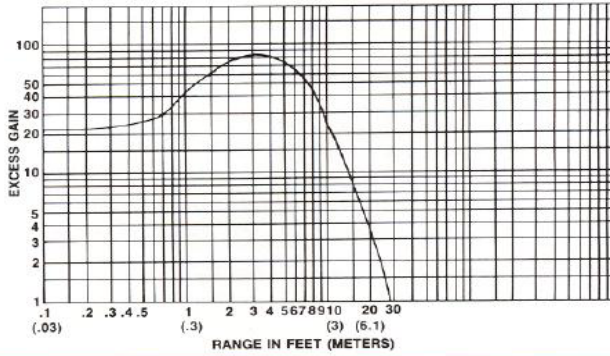

EFFECTIVE BEAM DIAMETER vs. RANGE

RETRO-REFLECTIVE

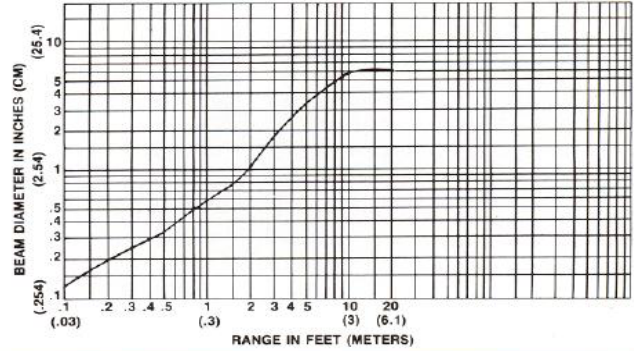

LONG-RANGE PROXIMITY

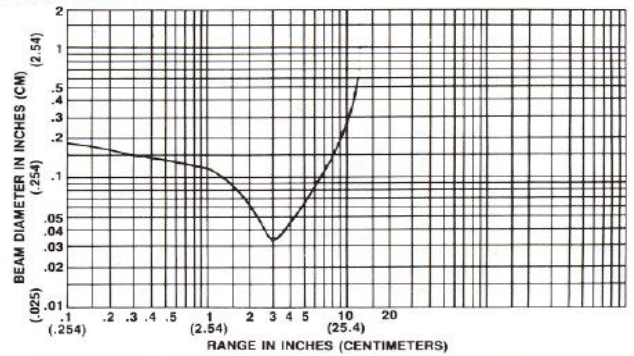
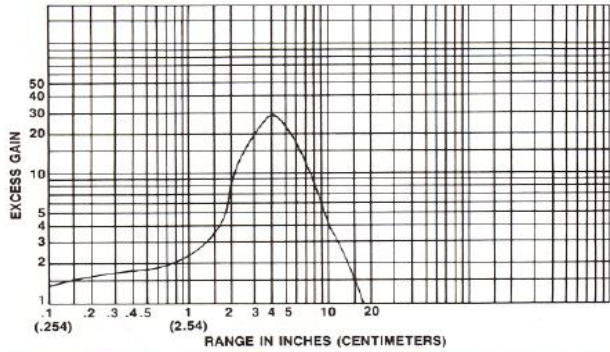

SHORT-RANGE PROXIMITY

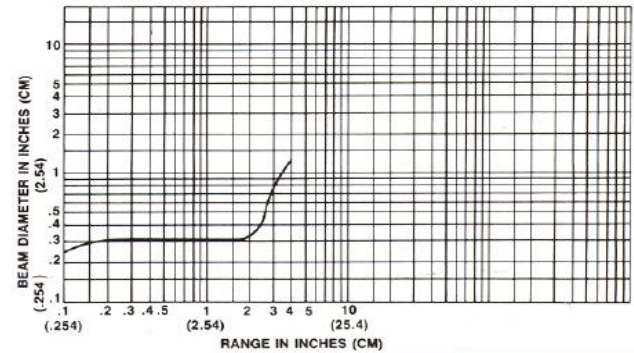
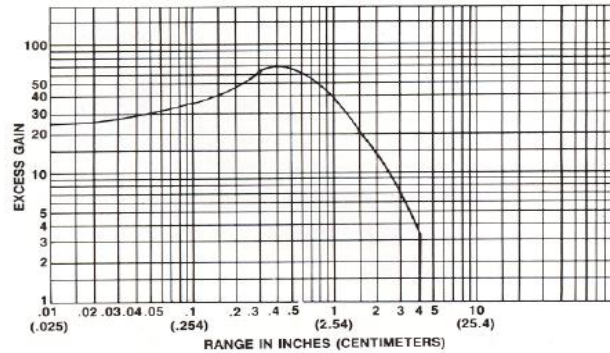

THROUGH BEAM

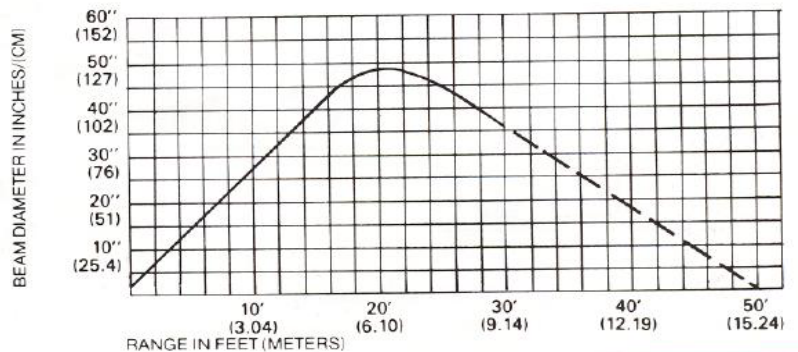
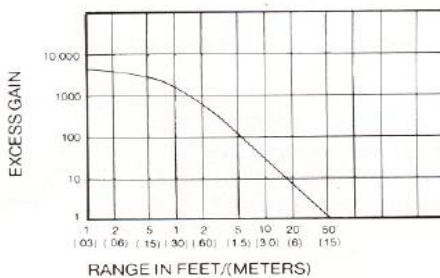

TYPICAL WIRING CONFIGURATIONS

2-Wire AC

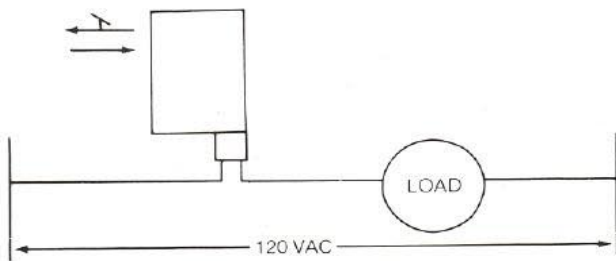

Standard hookup. Wires just like a conventional limit switch. Always make sure LOAD is connected in series with control.

2-Wire AC

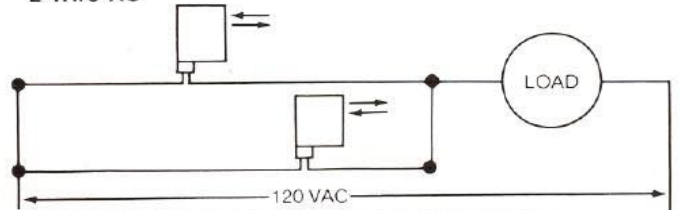

Parallel Operation. Either AND or OR logic can be obtained with proper selection of LIGHT or DARK phase. With LIGHT operate phase LOAD will energize when at least one control sees LIGHT and will be de-energized only when all see DARK.

With DARK operate phase LOAD will energize when at least one control sees DARK and will be de-energized only when all see LIGHT.

NOTE: Up to five (5) controls can be hooked up in parallel. In the parallel hook-up, OFF state leakage currents are additive.

2-Wire AC

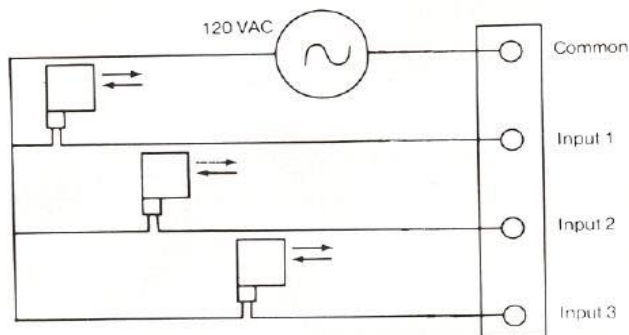

Connecting to 120 VAC Input Module on programmable controller. No polarity on wires.

5-Wire AC Relay

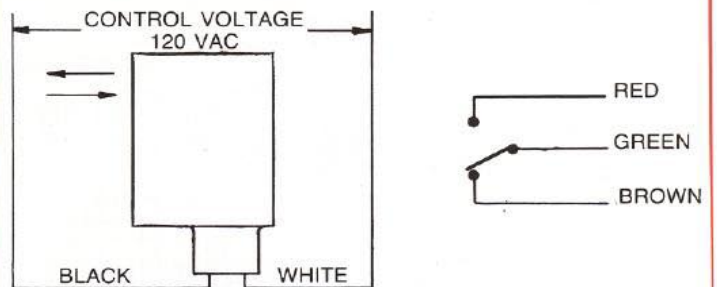

Connecting to SPDT relay output.

2-Wire AC Through-beam

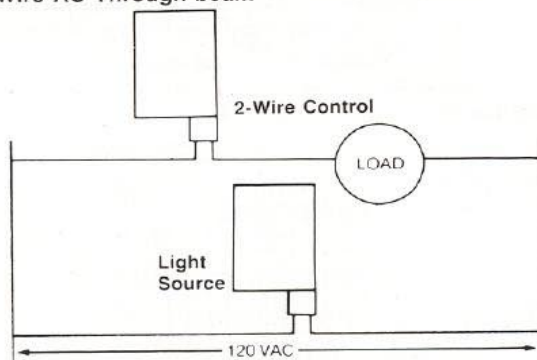

Standard hookup. The control wires like other 2-wire controls. The Light Source connects directly to the line voltage.

3-Wire DC

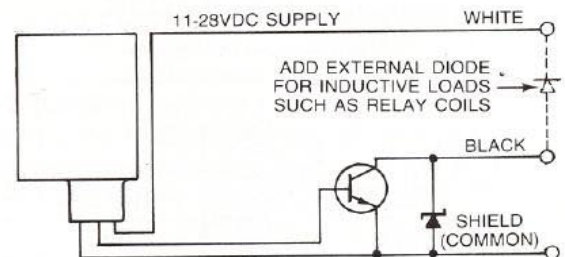

Connecting to current-sinking open-collector transistor output. (Transistor & Zener diode are inside the control.)

5-Wire DC Relay

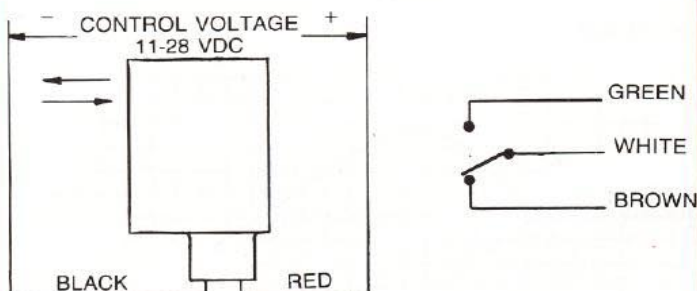

Connecting to SPDT relay output.

AND & OR Logic (DC)

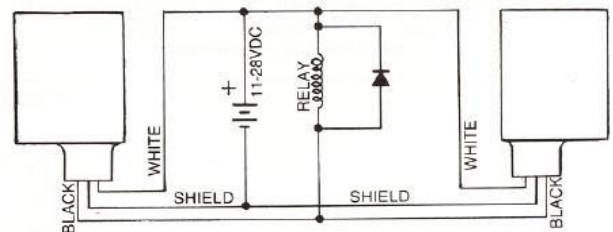

By parallel connections of outputs, either AND or OR Logic may be obtained.

AND Logic: Set phase switches to DARK position. Relay switches OFF when all light beams see target.

OR Logic: Set phase switches to LIGHT position. Relay switches ON when any light beam see target.

The outputs of several controls can be paralleled as easily as two shown.

A941B DC POWER AND RELAY MODULE

The A941B DC Power and Relay Module makes possible the operation of our A2 Series DC models from a standard 120VAC 50-60 HZ power source. The A941B is open style and mounts conveniently in a panel using standard 3" wide mounting track supplied.

The A941B allows easy addition of both time delay and electro-mechanical relay output into the system. An edge connector is provided to accept any of our many different function cards. No card is required for ON/OFF operation. The relay is plug-in and can be substituted with either plug-in logic or solid-state AC switch outputs. A red LED status indicator shows the state of the input. Hold-downs are provided for the function card and output device.

A maximum of four controls can be powered from a single A941B Module. Control outputs can be connected in parallel to the input terminals to create either series or parallel logic. This is possible because both LIGHT and DARK operation is available with the control phase switch.

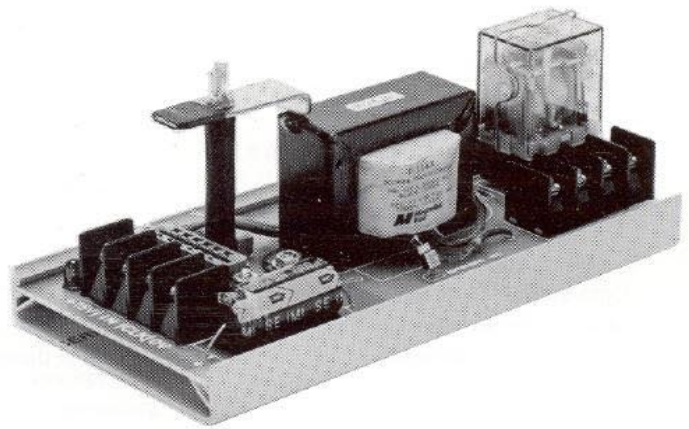

SPECIFICATIONS

Input

120VAC \pm 10%, 50-60 Hz.

Power Consumption

10 VA maximum

Output

Relay; DPDT contacts rated 10A resistive at 120VAC or 28VDC.

15VDC Supply Characteristics

Maximum Load Current: 200 ma
 Typical Output Voltage at 200 ma: 15V
 Typical Output Voltage at 0 ma: 18V
 Ripple Voltage (peak-to-peak) at 200 ma: 1.5V typical

Maximum Control Loading:

Four retro or prox controls
 or Two sets of through-beam controls.

Input (IN) Requirements

Sink 8 ma from an internal 8VDC supply

Ambient Operating Temperature Range

-40°C to +50°C (-40°F to +122°F)

Shipping Weight

1 lb.

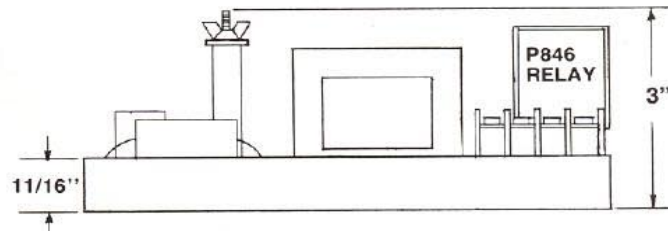
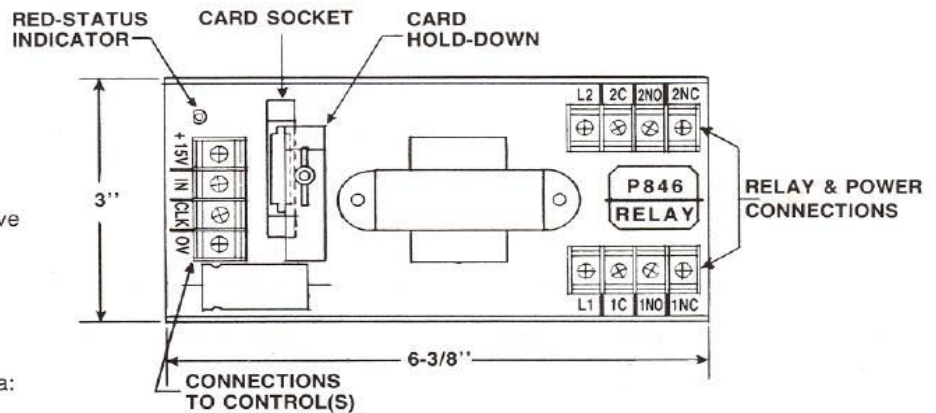

WIRING DIAGRAM

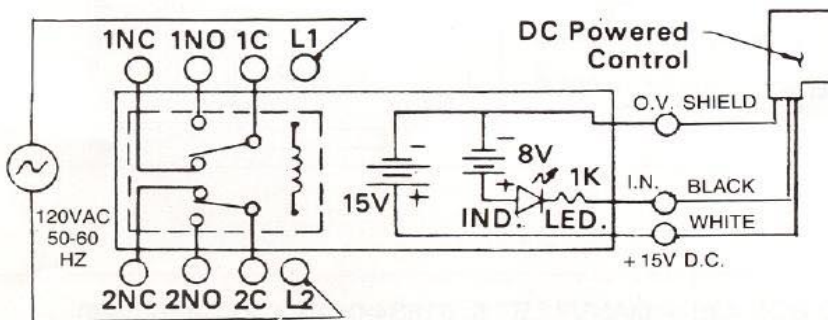

OPTIONS

- Adjustable time delays
- Quick disconnect receptacle (at right)
Order plug/cable assembly separately
- P939 swivel bracket



SPECIFICATIONS

General

Light Beam Distance (Both AC and DC Models):

Retro-reflective Models	
Off 3-inch diameter reflector	0-20 ft
Proximity Models	
Off 90% Diffuse White Surface	
Longer-Range Models	0-12 in
Shorter-Range Models	0-4 in
Through-Beam Models	0-20 ft

Light Source: GaAs LED

Sensor: Silicon phototransistor

Ambient Light Tolerance:
8000 foot candles

Ambient Operating Temperature:
0°F to 150°F
[-18°C to +70°C]

Enclosure:

Glass-filled Noryl® with acrylic lens, rated NEMA 1 and 12 tapped in bottom for 1/2-14 NPS conduit.

Shipping Weight: 1/2 lb.

Standard Cable Length: 6 feet

Sensitivity: Adjustable

Light/Dark Mode Selection: Slide Switch

AC Models

2-Wire

Hookup: 2-wire

Current Capacity (continuous):
.006 AMPS min, 0.5 AMPS max from
-18° to +50°C, derate linearly to
0.02 AMPS at 70°C.

Maximum Inrush Current:

8 AMPS for .0083 sec.
4 AMPS for 1.0 sec.

ON-State Voltage Drop:

10.7V typical

OFF-State Leakage Current:

1.7 ma max. on retro & prox models
(Consult factory on through-beam models)

OFF-State Operating Voltage:

85-130 VAC 50-60 Hz

Switching Device: Power MOSFET

Response Time (Light or Dark): .035 sec.

Relay

Hookup: 5-wire

Input: 120V ± 10% 50-60 Hz

Power Consumption: 4.5 VA

Output Relay: SPDT. Maximum contact rating is 0.5A, 120VAC resistive. Contact life is 100,000 cycles at contact rating.

Response Time (Light or Dark): .05 sec.

DC Models

Transistor

Hookup: 3-wire

Input Voltage: 11-28 VDC

Input Current:

Retro and Prox Models, 40 ma typical
Through-beam Control, 25 ma typical
Through-beam Source, 75 ma typical

Output Transistor Characteristics at 25°C:

Maximum switching (sinking) current:
100 ma DC

Maximum leakage current: 1 ua

Maximum On-State voltage:

Vce = 1.5 VDC @ 100 ma

Vce = 0.5 VDC @ 10 ma

Maximum Off-state voltage: 30 VDC

Maximum short circuit duration:

continuous at Vce = 5 VDC

10 sec. at Vce = 12 VDC

1 sec. at Vce = 24 VDC

Response Time (Light or Dark): .01 sec.

Relay

Hookup: 5-wire

Input: 11-28 VDC

Input Current:

Retro and Prox Models, 120 ma typical

Through-beam Control, 105 ma typical

Through-beam Source, 75 ma typical

Output Relay: SPDT. Maximum contact

rating is 0.5A, 120VAC resistive. Contact

life is 100,000 cycles at contact rating.

Response Time (Light or Dark): .05 sec.

ORDERING INFORMATION

A		2		0		2		6		6		R	
SERIES		INPUT/OUTPUT		OPTICAL CONFIGURATION		FUNCTION		TIME RANGE		OTHER OPTIONS			
Code	Description	Code	Input	No. Wires	Output	Code	Description	Code	Description	Code	Description	Code	Description
A2	Control	0	115VAC	2	Solid State Switch	0	Retro-reflective	0	On/Off	0	On/Off	(blank)	none
L2	Light source	1	115VAC	5	Electromechanical Relay	1	Long Range	1	On Delay	1	1 - 20 seconds	R	quick-disconnect receptacle
		2	115VAC	2	Light Source	2	Short Range	2	One Shot	3	Light Source		
		3	11-28VDC	3	Open Collector Transistor	2	Proximity	3	Relay output available only on Code 0	6	0.2 - 5 seconds		
		4	11-28VDC	5	Electromechanical Relay	3	Through-beam				Other ranges available upon request.		
		5	11-28VDC	2	Light Source								

Reflectors

Model No.	Diameter
P380*	3"
P380A	1 5/8"
P380AB	1 1/4"
P380B	3/8"
P380C	5/8"
P380MH*	3" (metal housing)
P380E	1 1/4" x 3" rectangle
P380F†	1 1/4" x 4" rectangle
3570 Tape	2" wide

*Has center mounting hole
†Has end mounting holes

Accessories

Model No.	Description
P939	Swivel Bracket

Order swivel bracket and reflector separately as required. Consult factory regarding quick-disconnect option.

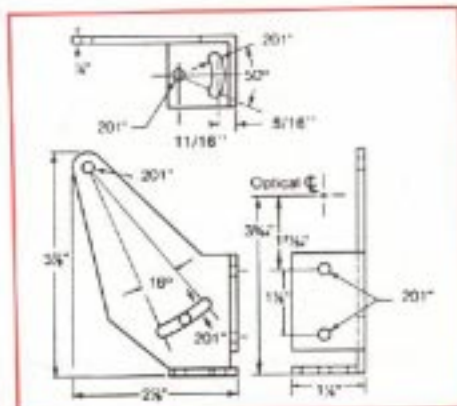
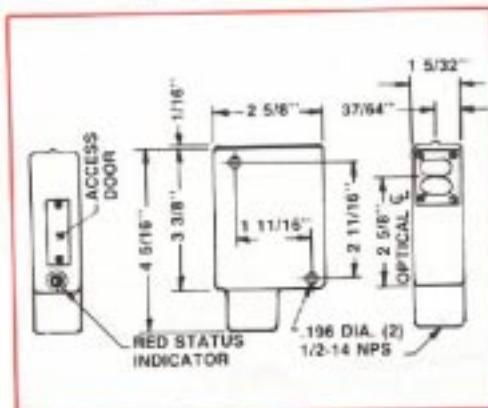

Autotron

ELWOOD CORP.-AUTOTRON GROUP • 217-446-3539
195 W. RYAN ROAD • OAK CREEK, WI 53154-4401 • 414-764-7500
TOLL FREE 800-637-2648 • FAX 414-764-4298